

I enlarged view

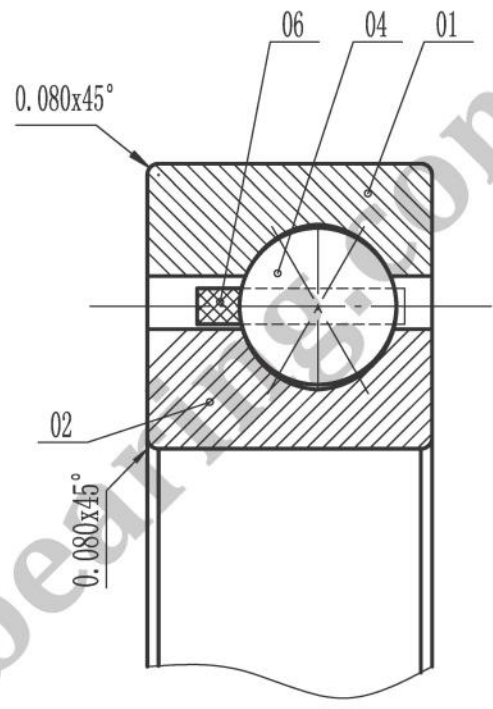

INA THIN SECTION BEARING

Formal drawing of CSXF075 will be submitted after contact with:
sales@jcb-bearing.com or sales@thinsectionbearings.com

06	cage		Brass			
04	steel ball		AISI 52100 Steel			
02	inner ring	1	AISI 52100 Steel			
01	outer ring	1	AISI 52100 Steel			
NO.	designation	qty.	material	unit	total	remark
				weight (lbs)		
Luoyang JCB Bearing Technology Co., Ltd Contact information Company Address : No.285 Fenghua road, Luoyang, Henan,China. Postal code : 471000 Phone : 0086-379-68611678 Fax : 0086-379-68611679 E-mail: sales@jcb-bearing.com Reserved E-mail: sales@thinsectionbearings.com Website: http://www.jcb-bearing.com https://www.thinsectionbearings.com				CSXF075		
						weight (lbs)
						3.4
				total page 1		page 1
				Luoyang JCB Bearing Technology Co., Ltd		